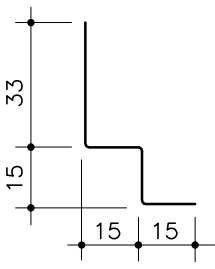
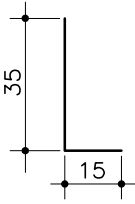
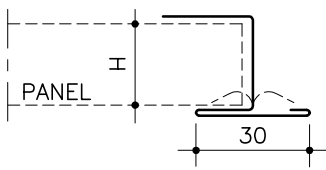
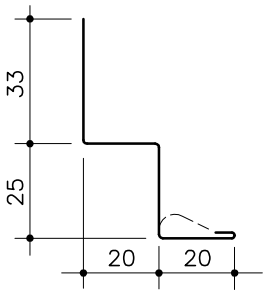
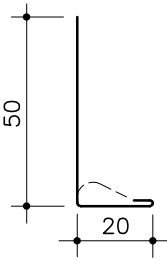
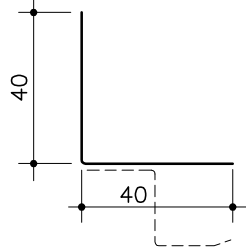
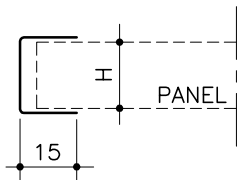
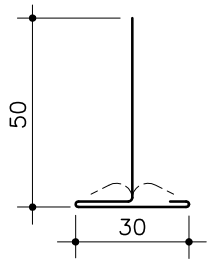

LAUTEX LISTS

Length= 3000

PAGE 1/3

<p>No. 30 DOUBLE-L-LIST</p>  <p>0.7 Al 0.14 kg/m</p>	<p>No. 33 L-LIST</p>  <p>0.7 Al 0.09 kg/m Can be bent</p>	<p>No. 36 PUSH SEAM LIST</p> <table border="1" data-bbox="1125 369 1300 481"> <thead> <tr> <th>No.</th> <th>H</th> </tr> </thead> <tbody> <tr> <td>36A</td> <td>15</td> </tr> <tr> <td>36B</td> <td>20</td> </tr> <tr> <td>36C</td> <td>25</td> </tr> </tbody> </table>  <p>1.0 Al 0.28 kg/m</p>	No.	H	36A	15	36B	20	36C	25																			
No.	H																												
36A	15																												
36B	20																												
36C	25																												
<p>No. 31 DOUBLE-L-LIST WITH TONGUE</p>  <p>0.7 Al 0.19 kg/m</p>	<p>No. 34 L-LIST WITH TONGUE</p>  <p>0.7 Al 0.14 kg/m</p>	<p>No. 50 L-LIST 40x40</p>  <p>1.0 Al 0.21 kg/m 1.0 Fe 0.62 kg/m</p>																											
<p>No. 32 U-END LIST</p> <table border="1" data-bbox="199 1422 550 1668"> <thead> <tr> <th>No.</th> <th>H</th> <th>Weight kg/m</th> </tr> </thead> <tbody> <tr><td>32A</td><td>15</td><td>0.09</td></tr> <tr><td>32B</td><td>20</td><td>0.10</td></tr> <tr><td>32C</td><td>25</td><td>0.10</td></tr> <tr><td>32D</td><td>30</td><td>0.11</td></tr> <tr><td>32E</td><td>35</td><td>0.12</td></tr> <tr><td>32F</td><td>40</td><td>0.13</td></tr> <tr><td>32G</td><td>48</td><td>0.15</td></tr> <tr><td>32H</td><td>50</td><td>0.15</td></tr> </tbody> </table>  <p>0.7 Al</p>	No.	H	Weight kg/m	32A	15	0.09	32B	20	0.10	32C	25	0.10	32D	30	0.11	32E	35	0.12	32F	40	0.13	32G	48	0.15	32H	50	0.15	<p>No. 35 T-LIST WITH TONGUE</p>  <p>1.0 Al 0.28 kg/m</p>	
No.	H	Weight kg/m																											
32A	15	0.09																											
32B	20	0.10																											
32C	25	0.10																											
32D	30	0.11																											
32E	35	0.12																											
32F	40	0.13																											
32G	48	0.15																											
32H	50	0.15																											

Latest information: www.lautex.com

All products are subject to modifications without prior notice 2011

LAUTEX LISTS

Length= 3000

Page 2/3

No. 51 Z-LIST

No.	H	Weight kg/m
51A	15	0.42
51B	20	0.44
51C	25	0.48
51D	30	0.54
51E	35	0.58
51F	40	0.62
51G	48	0.68
51H	50	0.70

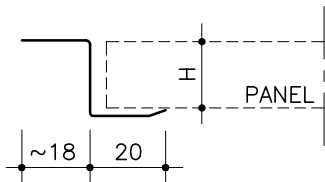

1.0 Steel (Weights in the table)
1.5 Al Can be bent

No. 53 U-INSERT LIST

No.	H	Weight kg/m
53A	15	0.10
53B	20	0.11
53C	25	0.12
53D	30	0.13
53E	35	0.14
53F	40	0.15

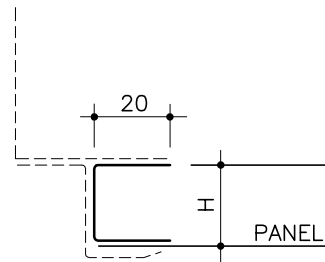

0.7 Al

No. 122 HAT LIST

FOR NBT-300/B0 & B15 CEILINGS

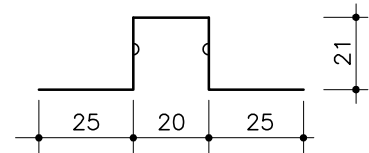

1.0 Steel
0.85 kg/m

No. 124 COVER PROFILE

FOR NBT-300/B0 & B15 CEILINGS

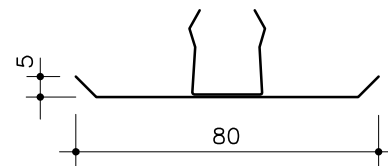

Steel
0.66 kg/m

No. 52 HAT LIST

No.	H	Weight kg/m
52A	15	0.23
52B	20	0.26
52C	25	0.29
52D	30	0.31
52E	35	0.34
52F	40	0.37
52G	48	0.39
52H	50	0.40

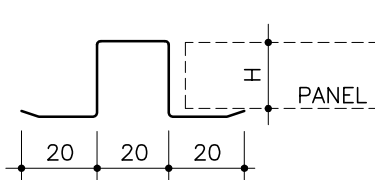

1.0 Al

No. 107 Z-INSERT LIST

No.	H	Weight kg/m
107A	15	0.16
107B	20	0.18
107C	25	0.19
107D	30	0.20
107E	35	0.22
107F	40	0.23

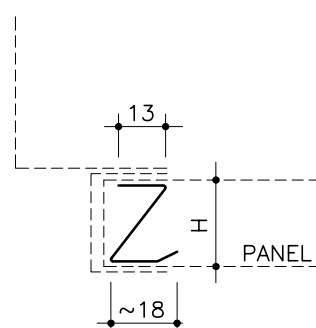

0.4 Steel

No. 125 L-LIST

FOR NBT-300/B0 & B15 CEILINGS

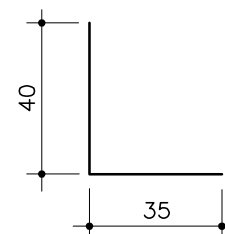

1.0 Steel
0.58 kg/m

LAUTEX LISTS

Length= 3000

Page 3/3

No. 126 SEALING PROFILE
FOR NBT-300/B0 CEILINGS

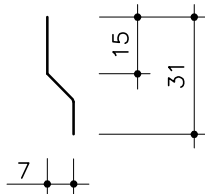

1.0 Fe
0.25 kg/m

No. 128 Z-PROFILE
FOR NBT-300/B15 CEILINGS

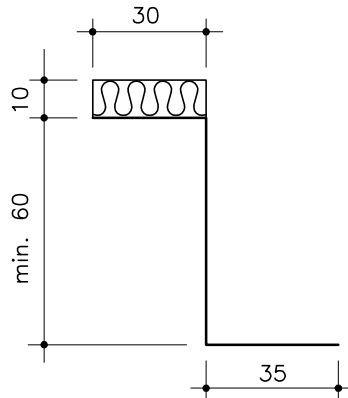

1.0 Fe
1.02 kg/m (h=60)

No. 127 Z-PROFILE
FOR NBT-300/B0 CEILINGS

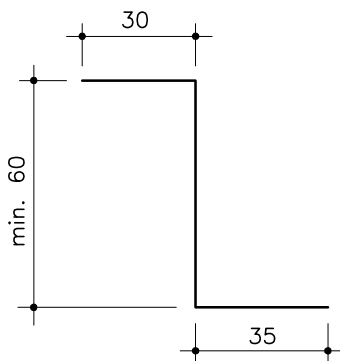

1.0 Fe
0.97 kg/m (h=60)

CURVED LISTS - DIRECTION OF RADIUS

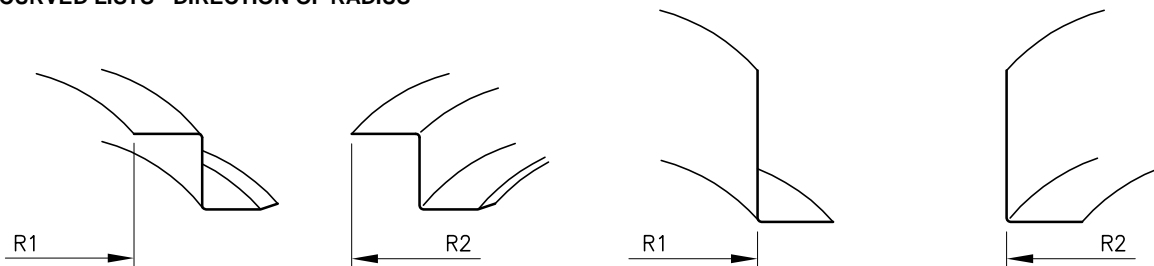

Latest information: www.lautex.com

All products are subject to modifications without prior notice 2011